

NM4, NMS4 Close Coupled Centrifugal Pumps

n ≈ 1450 rpm



3



The electropumps NM4, B-NM4, NMS4, B-NMS4 series comply with the European Regulation no. 547/2012 in force starting from 01.01.2013

Materiali

Components	NM4, NMS4	B-NM4, B-NMS4
Pump casing Lantern bracket NM4 Casing cover for NMS4	Cast iron GJL 200 EN 1561	Bronze G-Cu Sn 10 EN 1982
Lantern bracket NMS4	Cast iron GJL 200 EN 1561	
Impeller	Cast iron GJL 200 EN 1561	Bronze G-Cu Sn 10 EN 1982
	Brass P- Cu Zn 40 Pb 2 UNI 5705 For NM4 25/125 - 25/160 - 25/200 - NM4 32/16 - 32/20 - 40/20	
Shaft	AISI 303 up to 1,1 kW	Cr Ni Mo steel
	AISI 430 from 1,5 kW to 75 kW	AISI 316
Mechanical seal	Carbon - Ceramic - NBR	
Counter-flanges	Steel Fe 430B UNI 7070	

Construction

Close-coupled centrifugal pumps; electric motor with extended shaft directly connected to the pump up to 15 kW, new bracket construction for standard motors (Stub-shaft construction) from 18,5 to 75 kW with integrated thrust bearing. Pump casing with axial suction and radial delivery on top, main dimensions and performance according to EN 733 with additional sizes for completion. NM(S)4: version with pump casing and lantern bracket in cast iron. B-NM(S)4: version with pump casing and lantern bracket/casing cover in bronze. (the pumps are supplied fully painted).

Connections

Sizes	Connections
NM4 25/...	Threaded ports ISO 228
from NM4 32/.. to NMS4 150/..	Flanges according to PN 10, EN 1092-2

Counter-flanges (on request)

Sizes	Flanges
from NM4 32/.. to NM4 50/..	Screwed flanges EN 1092-1, PN 16
from NM4 32/.. to NMS4 150/..	Flanges for welding EN 1092-1, PN 10

Applications

For clean liquids without abrasives, which are non-aggressive for the pump materials (contents of solids up to 0,2%). For water supply. For heating, air conditioning, cooling and circulation plants. For civil and industrial applications. When low noise operating is required. For irrigation.

Operating conditions

Liquid temperature from -10 °C to +90 °C.
Ambient temperature up to 40 °C.
Total suction lift up to 7 m.
Maximum permissible working pressure up to 10 bar.
Continuous duty.

Motor

4-pole induction motor, 50 Hz (n ≈ 1450 rpm).
NM4, NMS4: three-phase 230/400 V ± 10% up to 3 kW;
400/690 V ± 10% from 4 to 75 kW.
Insulation class F. Protection IP 54 (IP 55 for NMS4).
Motor suitable for operation with frequency converter from 1,1 kW.
Classification scheme IE2 for three-phase motor from 0,75 kW.
Constructed in accordance with: EN 60034-1; EN 60034-30.

Special features on request

- Other voltages. - Frequency 60 Hz (as per 60 Hz data sheet).
- Protection IP 55. - Special mechanical seal.
- Higher or lower liquid or ambient temperatures.
- Motor suitable for operation with frequency converter up to 0,75 kW.

Coverage chart n ≈ 1450 rpm

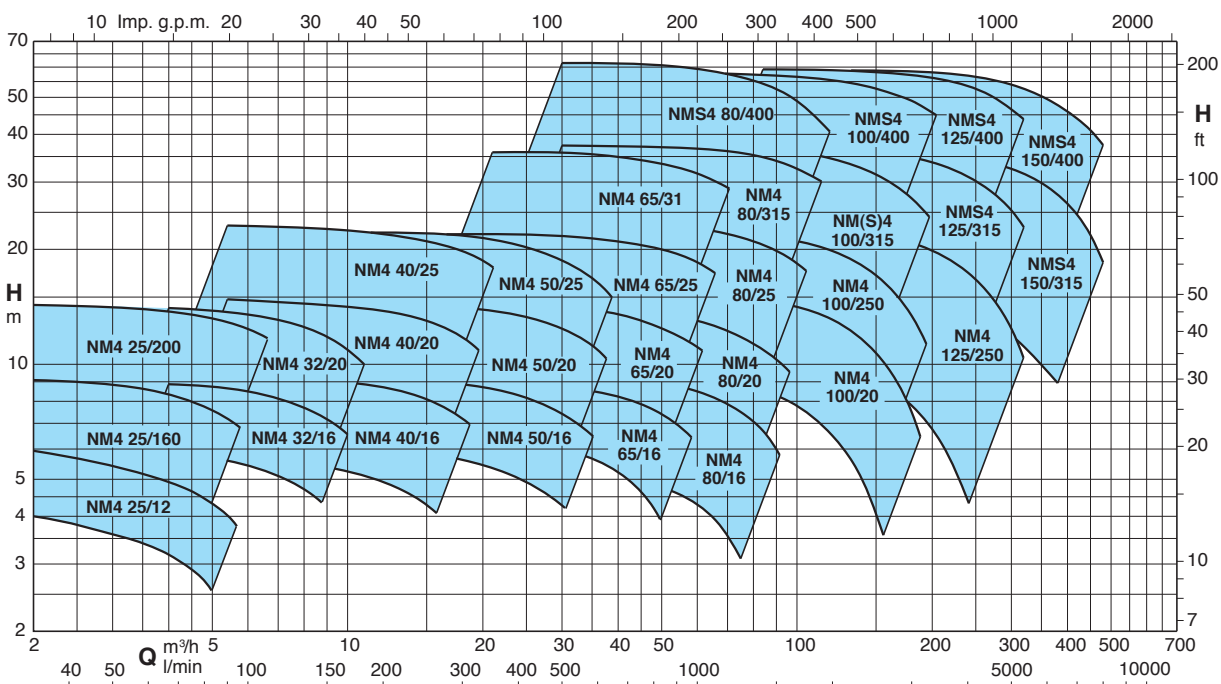

Performance n ≈ 1450 rpm

B-NMS4	NM4 - NMS4	P ₂		Q m ³ /h	H (m)																	
		kW	HP		l/min																	
				800	900	1000	1100	1250	1400	1600	1800	2000	2200	2500	2800	3000	3200	3500	4000	4500	5000	5500
	NM4 100/20C/A	3	4	9,4	9,3	9,2	9,1	8,9	8,5	8	7,3	6,5	5,6	4								
	NM4 100/20B/A	4	5,5	12	11,9	11,8	11,7	11,5	11,2	10,7	10	9,3	8,4	6,7	4,5							
	NM4 100/20A/A	5,5	7,5	15,2	15,2	15,1	15	14,9	14,7	14,3	13,8	13,1	12,2	10,7	9	7,5*	6*					
	NM4 100/25B/A	7,5	10	19,5	19,5	19,4	19,3	19	18,7	18,2	17,5	16,6	15,6	13,8	11,7	10	8,4	5,5				
	NM4 100/25A/A	9,2	12,5	22,3	22,3	22,2	22,1	21,9	21,7	21,2	20,5	19,8	18,8	17,1	15	13,4	11,7	8,9				
B-NMS4 100/315C	NM4 100/315C/A	11	15	26,9	26,9	26,8	26,6	26,2	25,7	24,9	23,8	22,7	21,3	18,9	15,9	13,7	11,3*					
B-NMS4 100/315B	NM4 100/315B/A	15	20	31,5	31,5	31,4	31,3	31,2	30,8	30,2	29,3	28,2	26,9	24,6	21,8	19,8	17,6*	14*				
B-NMS4 100/315A	NMS4 100/315A	18,5	25	36,9	36,9	36,8	36,7	36,6	36,4	36	35,3	34,5	33,4	31,4	29	27,2	25,3*	22,2*				
B-NMS4 100/400C	NMS4 100/400C	22	30	41,3	41,2	41,1	41	40,7	40,4	39,8	39	38	36,5	34	31	28,7	26					
B-NMS4 100/400B	NMS4 100/400B	30	40	50,2	50,1	50	49,9	49,7	49,4	48,8	48	47,1	46	44	41,3	39,5	37	33,5*				
B-NMS4 100/400A	NMS4 100/400A	37	50	58,2	58,1	58	57,9	57,8	57,6	57,2	56,3	55,7	54,5	52,7	50,5	49	47	44*				

3

B-NMS4	NM4 - NMS4	P ₂		Q m ³ /h	H (m)																	
		kW	HP		l/min																	
				1400	1600	1800	2000	2200	2500	2800	3000	3200	3500	4000	4500	5000	5500	6000	6500	7000	7500	8000
	NM4 125/25E/A	5,5	7,5	11	10,8	10,5	10,1	9,7	9,1	8,3	7,8	7,2	6,2	4,4								
	NM4 125/25D/A	7,5	10	14	13,9	13,7	13,4	13	12,4	11,6	11	10,4	9,4	7,4	5,1							
	NM4 125/25C/A	9,2	12,5	16,7	16,6	16,4	16,2	15,9	15,4	14,6	14,1	13,5	12,5	10,4	8,2	5,8						
B-NMS4 125/250B	NM4 125/250B/A	11	15	19,3	19,2	19,1	18,9	18,7	18,2	17,5	17	16,3	15,3	13,3	10,9	8,2						
B-NMS4 125/250A	NM4 125/250A/A	15	20	22,7	22,7	22,6	22,4	22,2	21,8	21,2	20,8	20,1	19,3	17,4	15	12,4	9,3					
B-NMS4 125/315C	NMS4 125/315C	18,5	25	27,9	27,8	27,7	27,6	27,2	26,5	25,6	24,9	24	22,8	20,2	17	13,5	9,5*					
B-NMS4 125/315B	NMS4 125/315B	22	30	31,8	31,7	31,6	31,5	31,1	30,6	29,7	29,1	28,5	27,3	24,9	22	18,5	14,3*					
B-NMS4 125/315A	NMS4 125/315A	30	40	36,8	36,8	36,7	36,6	36,4	35,9	35,2	34,7	34,2	33,2	31	28,4	25,3	21,6*					
B-NMS4 125/400C	NMS4 125/400C	37	50	45,4	45,3	45,2	45,1	44,9	44,4	43,7	43	42	40	37	33	28,5*	23,5*					
B-NMS4 125/400B	NMS4 125/400B	45	60	51,4	51,3	51,2	51,1	50,9	50,4	49,7	49	48,2	46,8	44	40,5	36*	31,5*					
B-NMS4 125/400A	NMS4 125/400A	55	75	59,2	59,1	59	58,9	58,7	58,2	57,7	57,2	56,7	55,7	53,5	50,5	46,5*	42,5*					
B-NMS4 150/315D	NMS4 150/315D	18,5	25					22,8	22,6	22,3	22	21,7	21,1	20	18,6	17	15,1	13	10,6	8*		
B-NMS4 150/315C	NMS4 150/315C	22	30					25,6	25,4	25,1	24,9	24,7	24,2	23,3	22	20,4	18,5	16,5	14,1	11,6*	8,9*	
B-NMS4 150/315B	NMS4 150/315B	30	40					30,6	30,6	30,5	30,3	30,1	29,7	29	27,9	26,5	24,9	23	20,8	18,3*	15,4*	
B-NMS4 150/315A	NMS4 150/315A	37	50					35,6	35,6	35,5	35,4	35,3	35,2	34,6	33,7	32,5	31	29,2	27,1	24,7*	21,8*	18,5*
B-NMS4 150/400C	NMS4 150/400C	45	60					45	44,9	44,7	44,5	44	43,5	42,5	40,5	38,5	36	33,5	30,5	27*	23,5*	19,5*
B-NMS4 150/400B	NMS4 150/400B	55	75					50,8	50,7	50,5	50,3	50	49,5	48,5	47	45	43	40,5	38	35*	32*	28,5*
B-NMS4 150/400A	NMS4 150/400A	75	100					58,8	58,7	58,6	58,5	58,3	57,9	57	55,5	54	52	49,5	47	44*	41*	37,5

NM4, NMS4 Standard construction.
 B-NM4, B-NMS4 Bronze construction.

P₂ Rated motor power output.
 H Total head in m.

* Maximum suction lift 1-2 m.
 Tolerances according to UNI EN ISO 9906:2012

Regulation (EU) No 547/2012

- The benchmark for most efficient water pumps is MEI ≥ 0,70.
- The efficiency of a pump with a trimmed impeller is usually lower than that of a pump with the full impeller diameter. The trimming of the impeller will adapt the pump to a fixed duty point, leading to reduced energy consumption. The minimum efficiency index (MEI) is based on the full impeller diameter.
- The operation of this water pump with variable duty points may be more efficient and economic when controlled, for example, by the use of a variable speed drive that matches the pump duty to the system.

Rated currents

P ₂		230 V Δ / 400 V Y		
kW	HP	In A	In A	IA/In
0,25	0,34	1,4	0,8	3,7
0,37	0,5	1,65	0,95	4,2
0,55	0,75	2,6	1,5	4,8
0,75	1	3,3	1,9	5,2
1,1	1,5	5	2,9	4,7
1,5	2	6	3,5	5
2,2	3	8,6	5	6,1
3	4	11,1	6,4	9

P ₂		400 V Δ / 690 V Y		
kW	HP	In A	In A	IA/In
4	5,5	8,3	4,8	9,3
5,5	7,5	12,5	7,2	7,7
7,5	10	16	9,2	9,4
9,2	12,5	19	11	9,3
11	15	22,5	13	6,9
15	20	29	16,7	7
18,5	25	34,5	19,9	6,4
22	30	40,5	23,4	6,7
30	40	55	31,8	6,7
37	50	67	38,5	6,8
45	60	81	46,8	6,9
55	75	96	55,4	7,5
75	100	130	75	6,8

P₂ Rated motor power output.
 IA/In D.O.L. starting current / Nominal current

Characteristic curves $n \approx 1450$ rpm

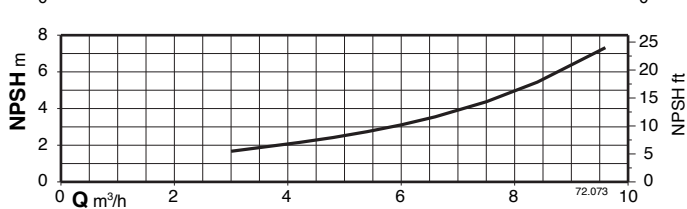
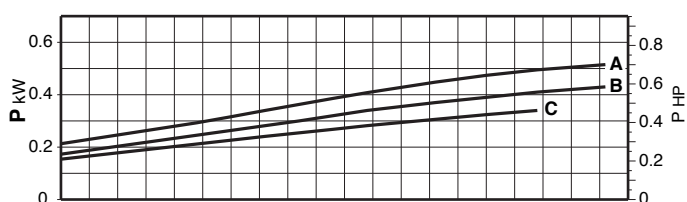
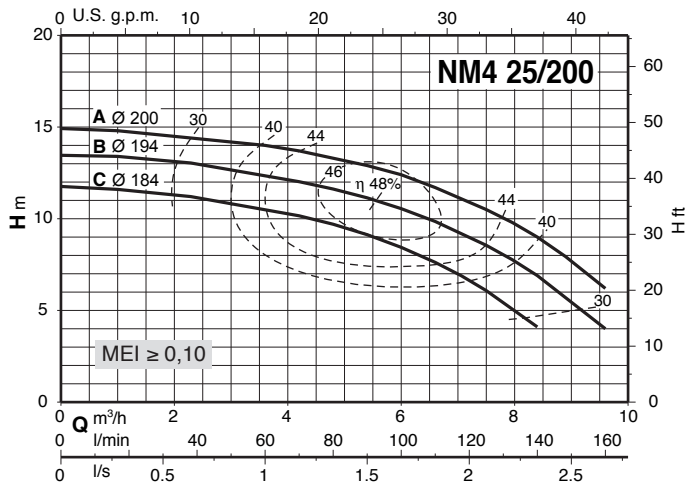
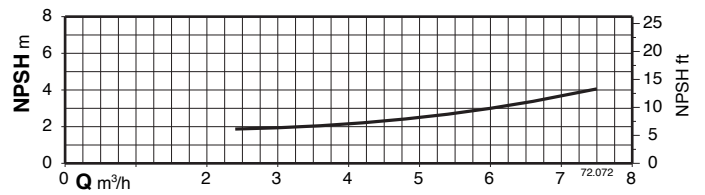
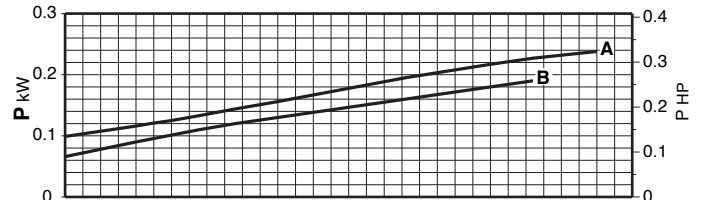
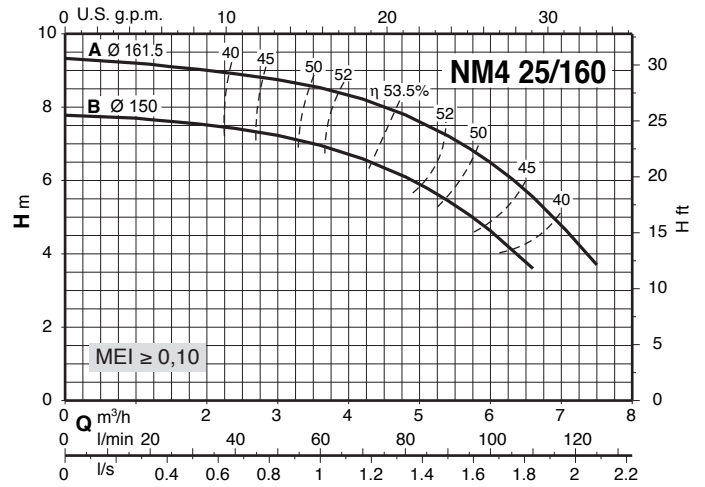
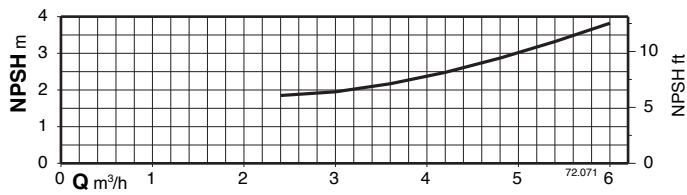
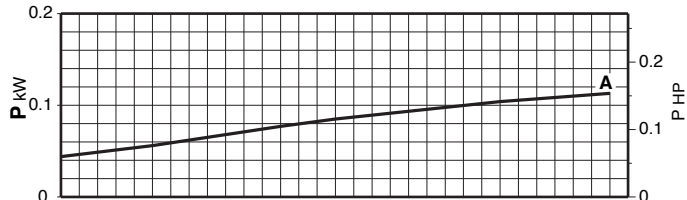
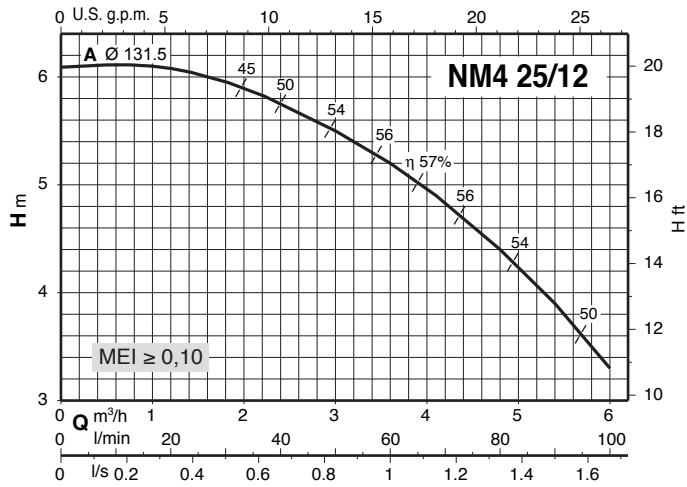

Characteristic curves $n \approx 1450$ rpm

3

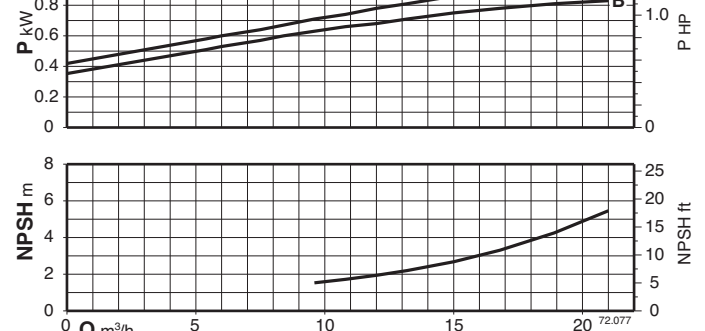
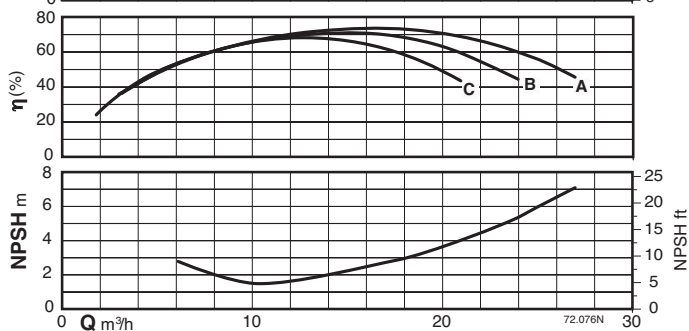
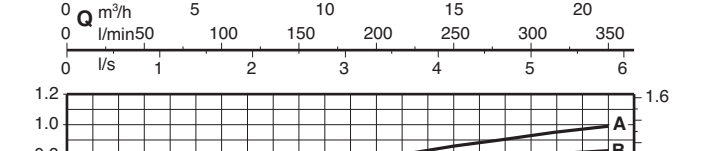
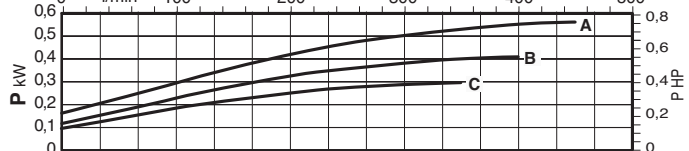
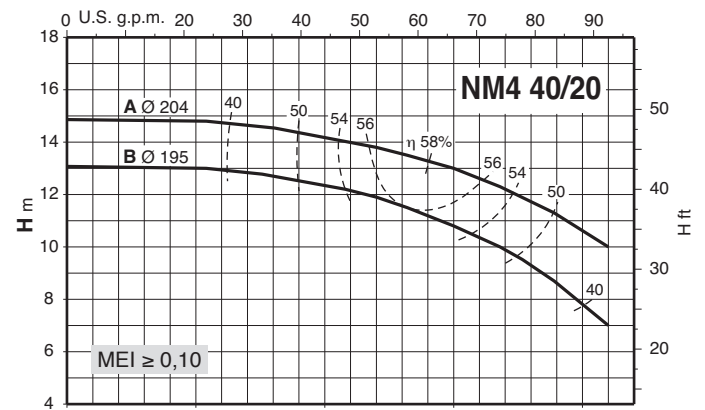
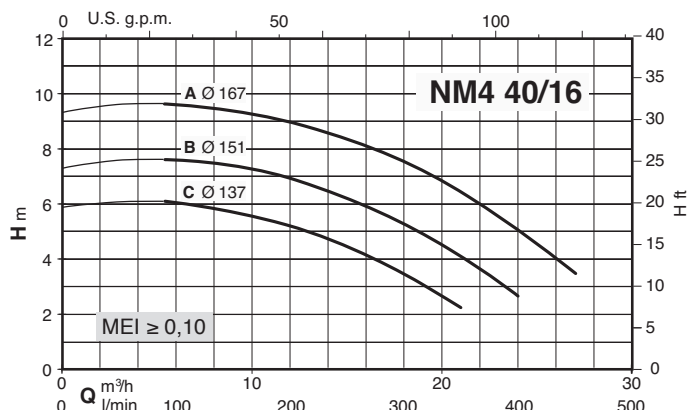
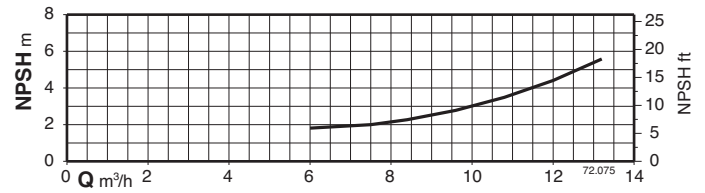
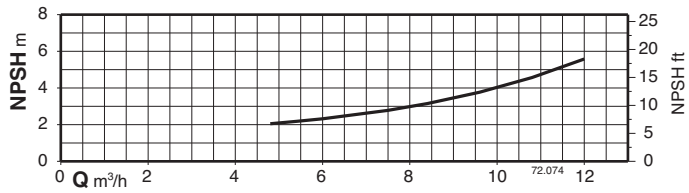
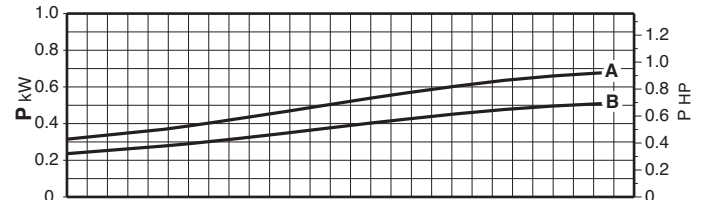
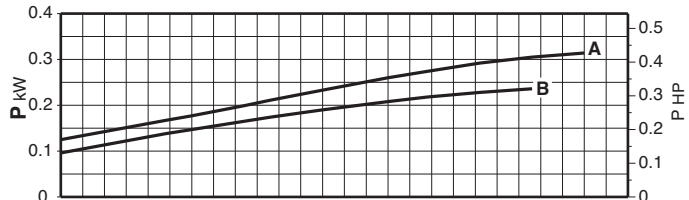
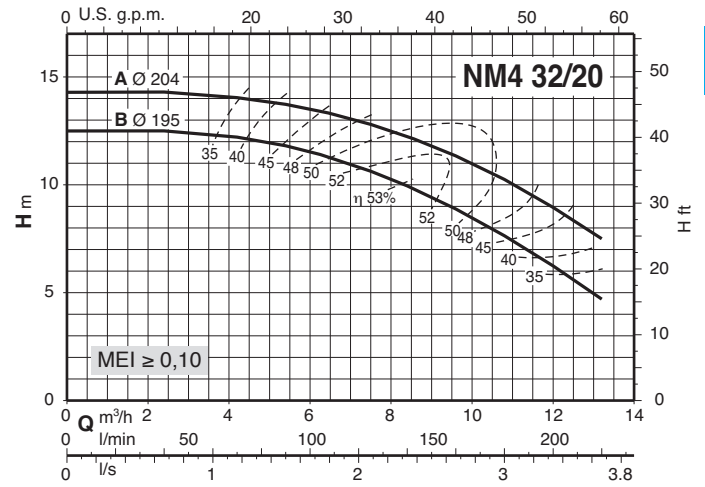
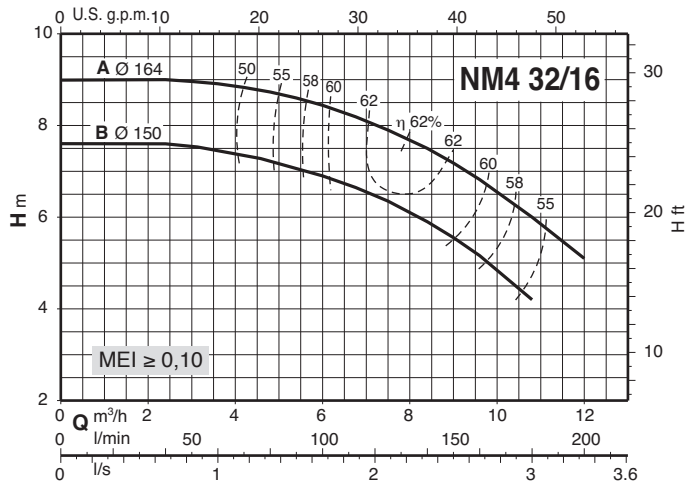

Characteristic curves $n \approx 1450$ rpm

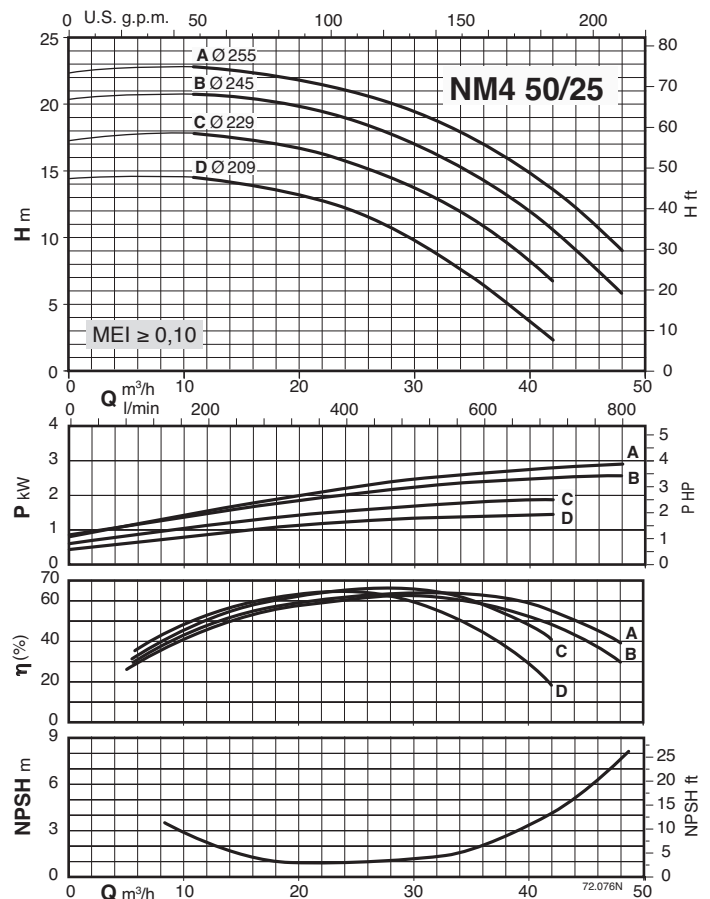
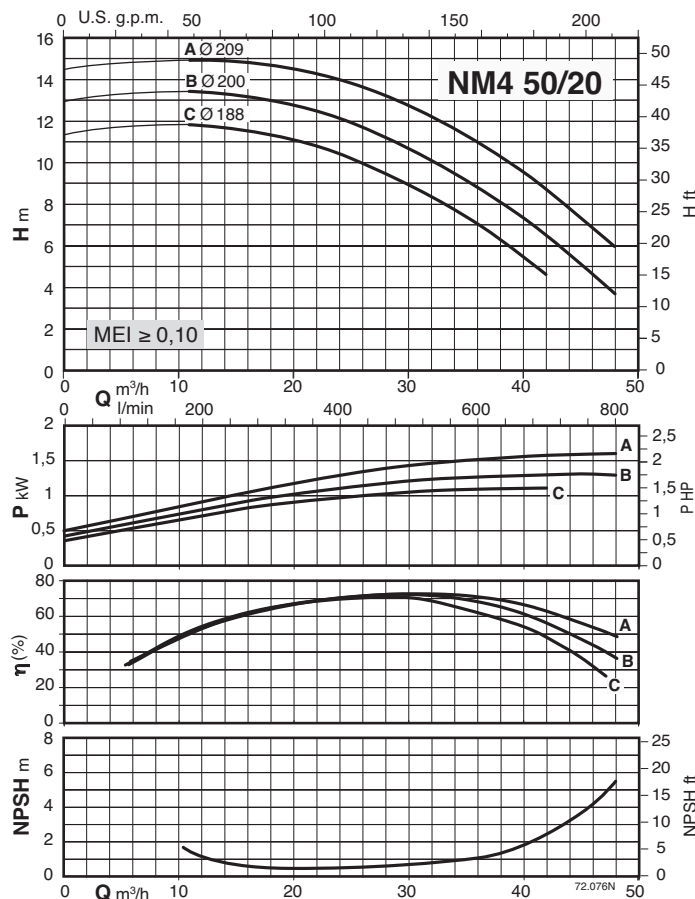
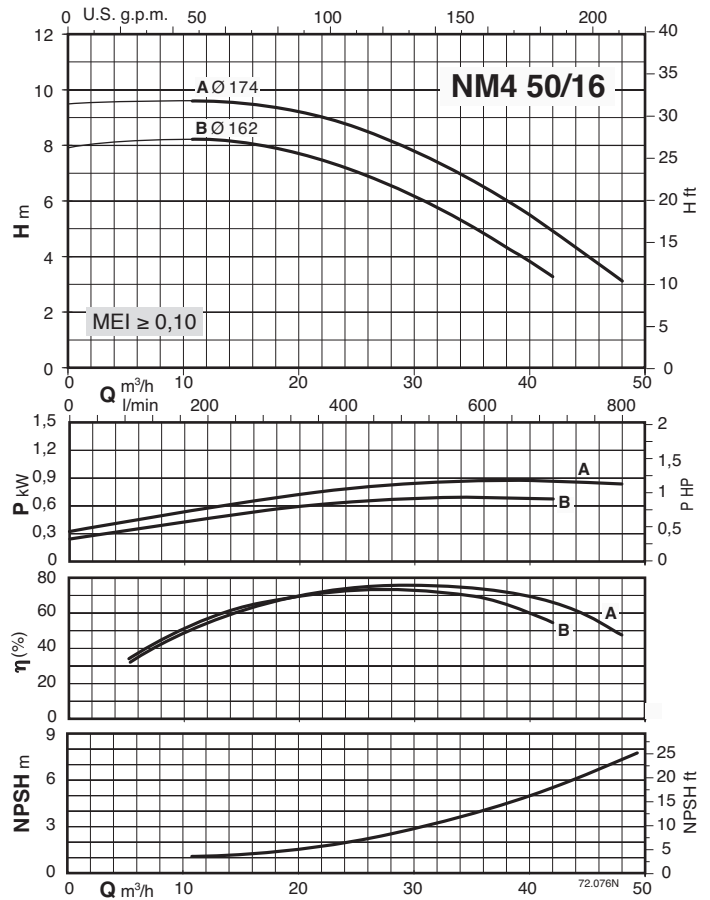
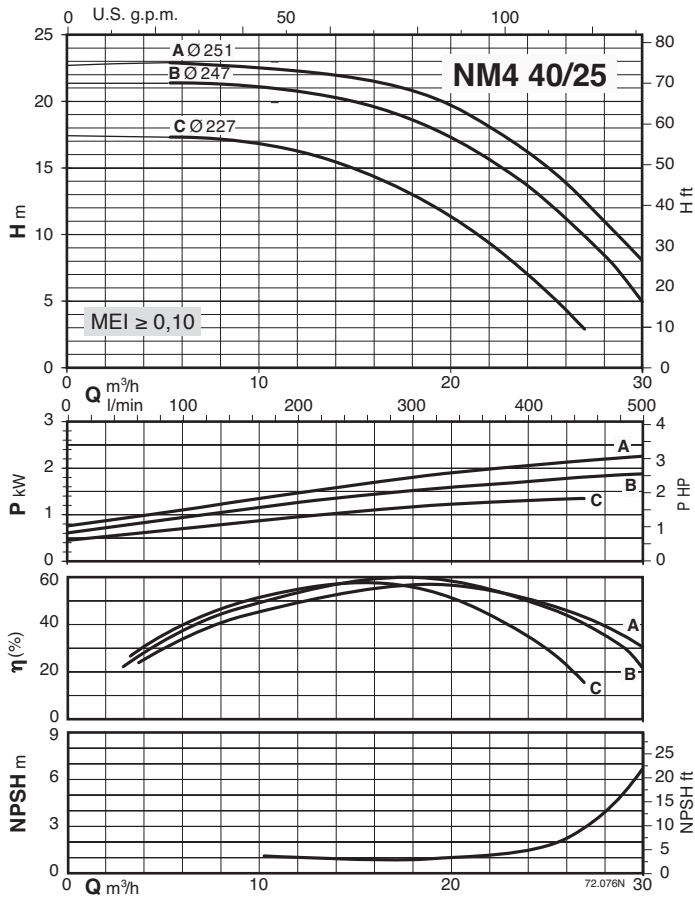

Characteristic curves $n \approx 1450$ rpm

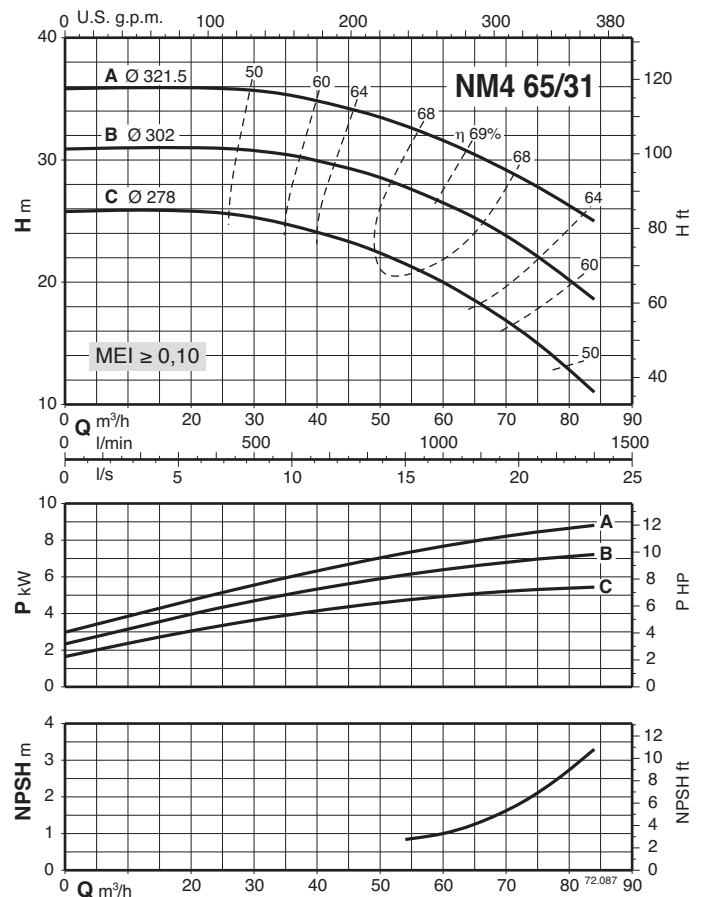
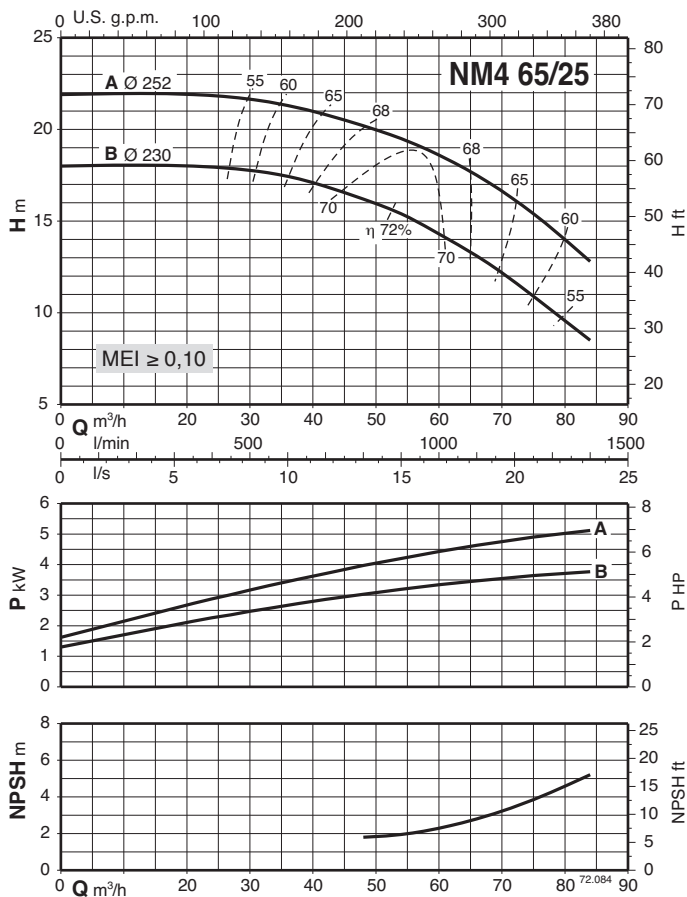
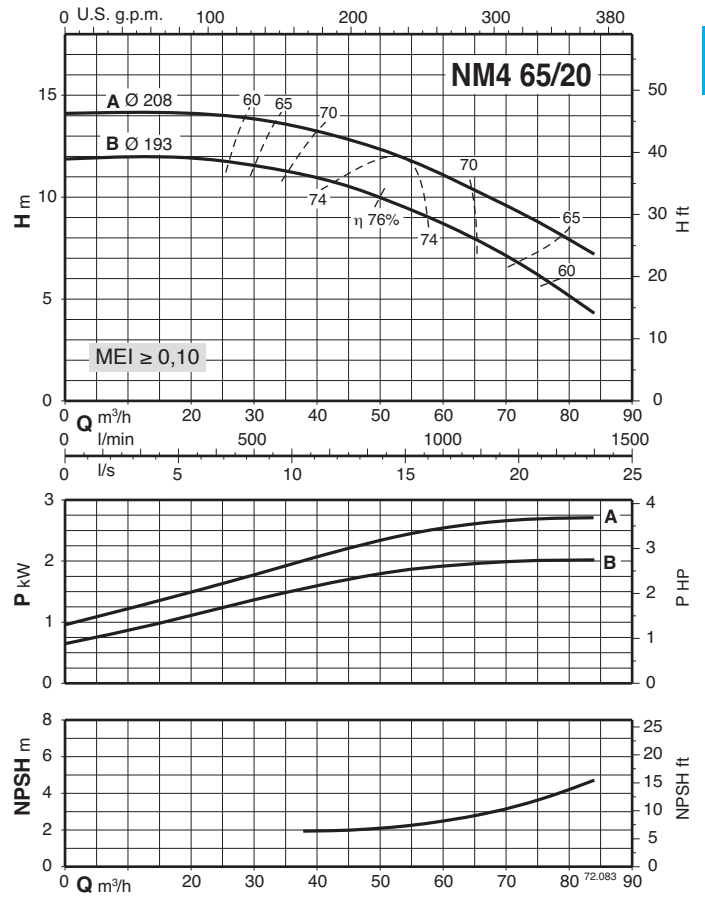
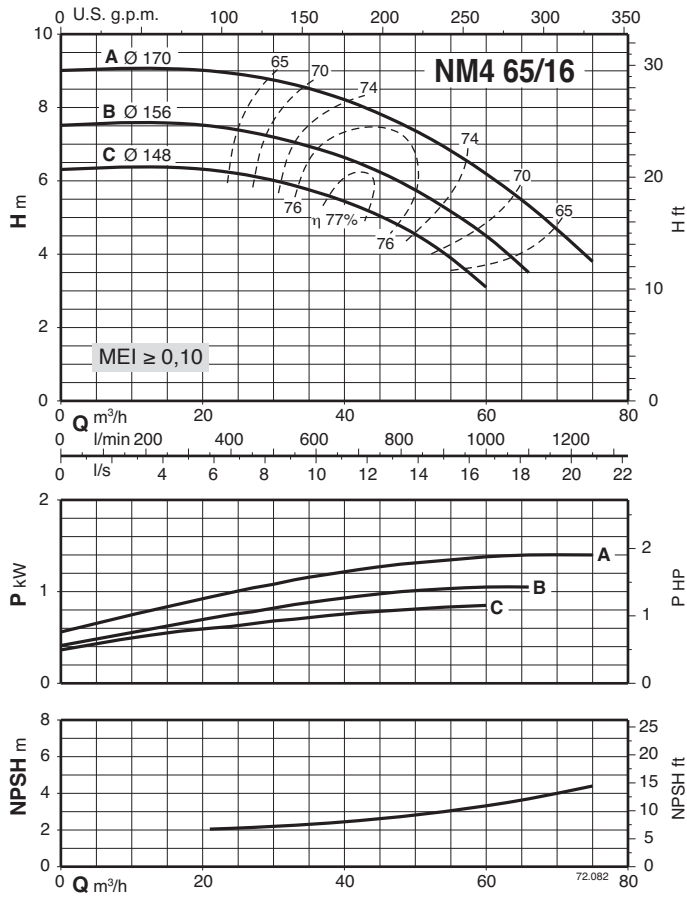

Characteristic curves $n \approx 1450$ rpm

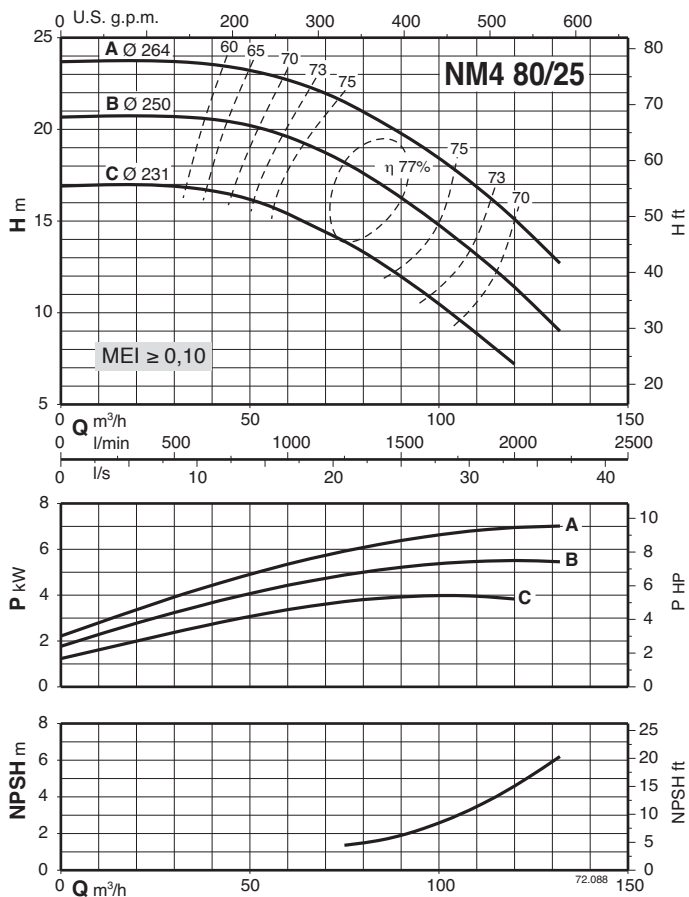
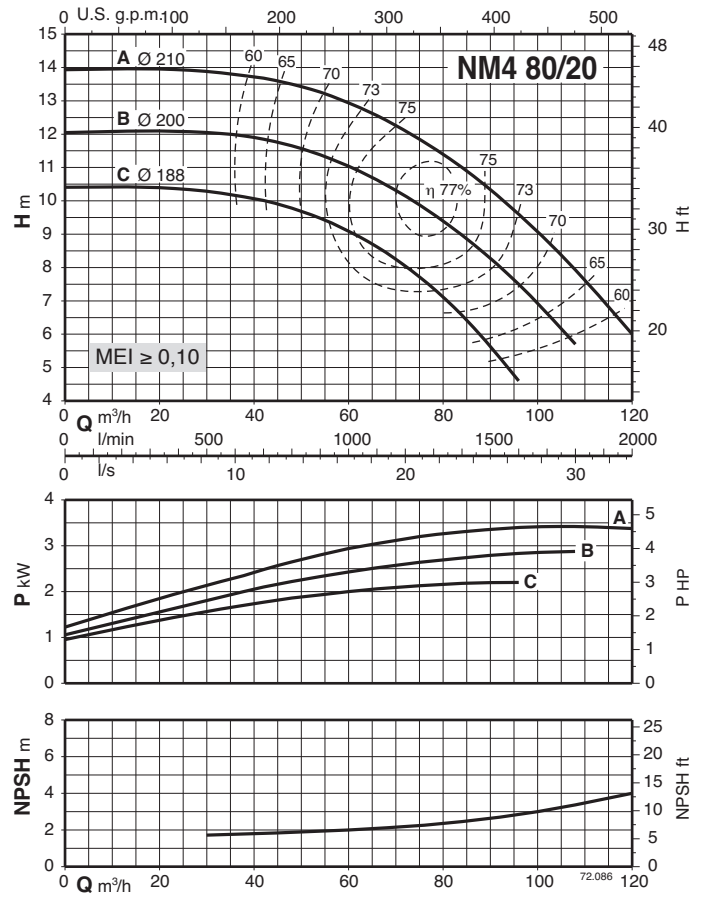
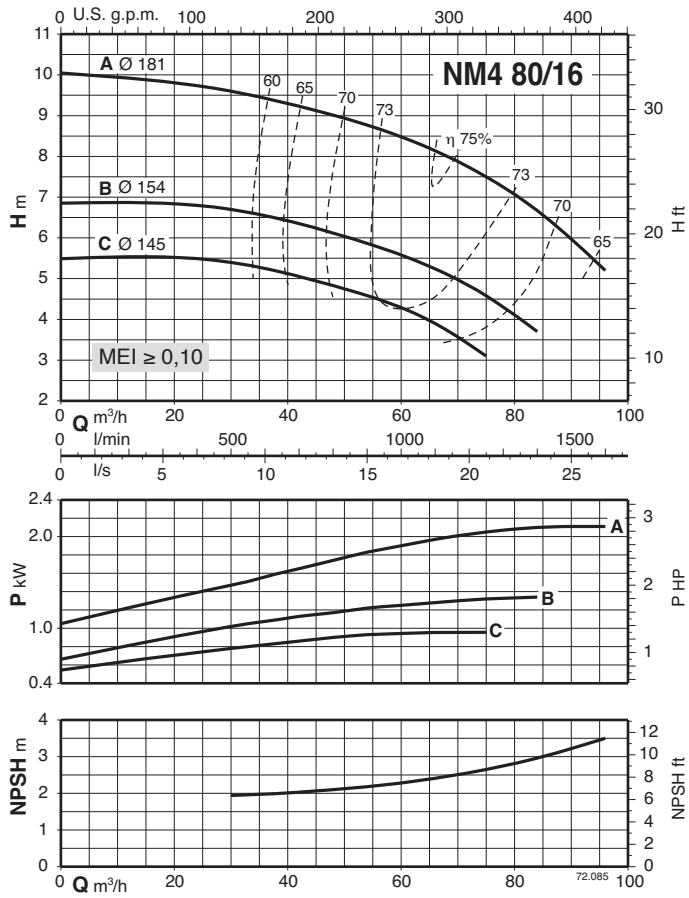

Characteristic curves $n \approx 1450$ rpm

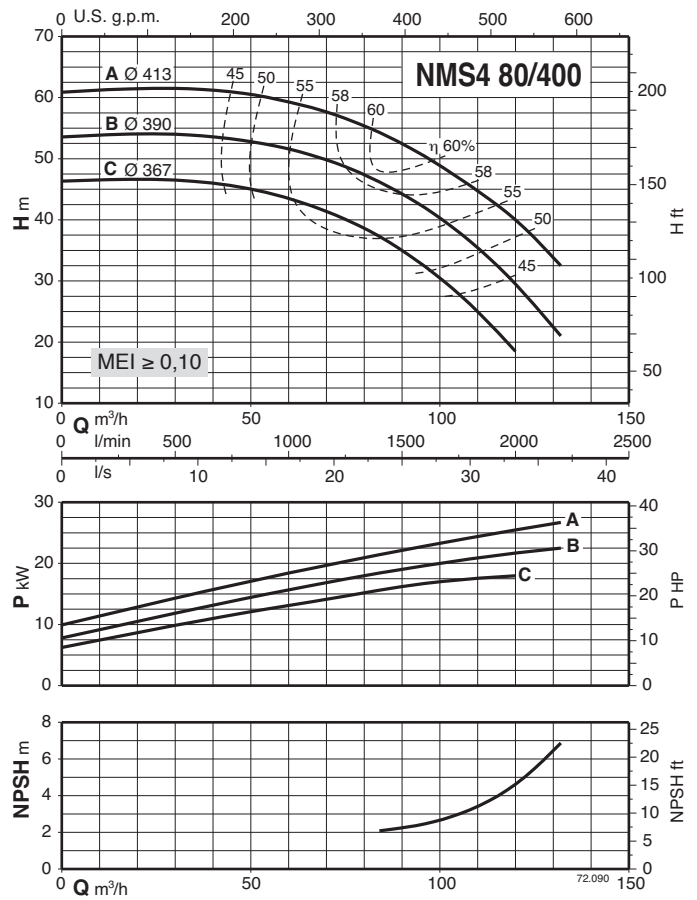
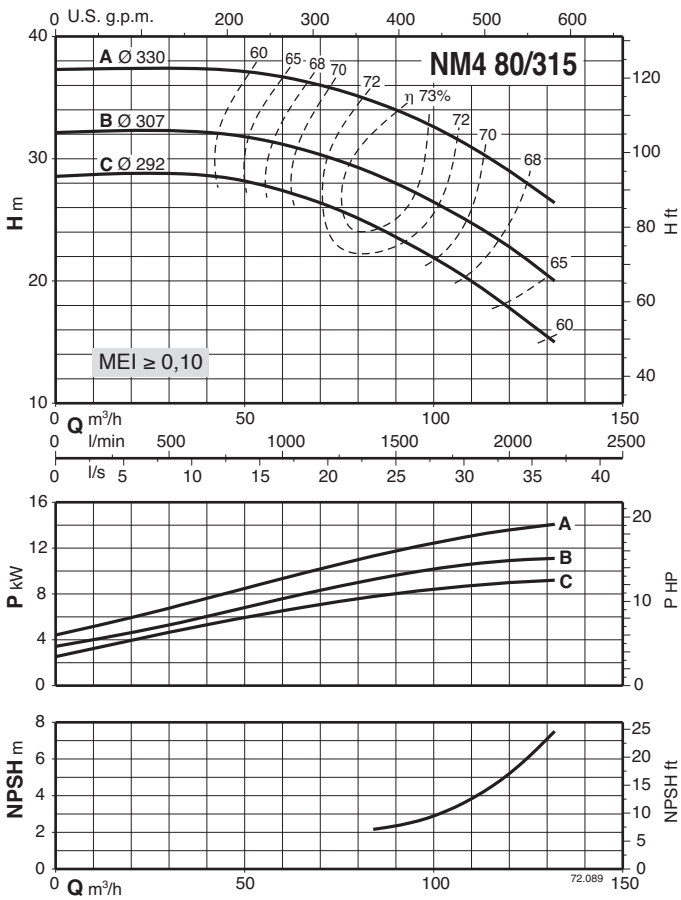

3

Characteristic curves $n \approx 1450$ rpm

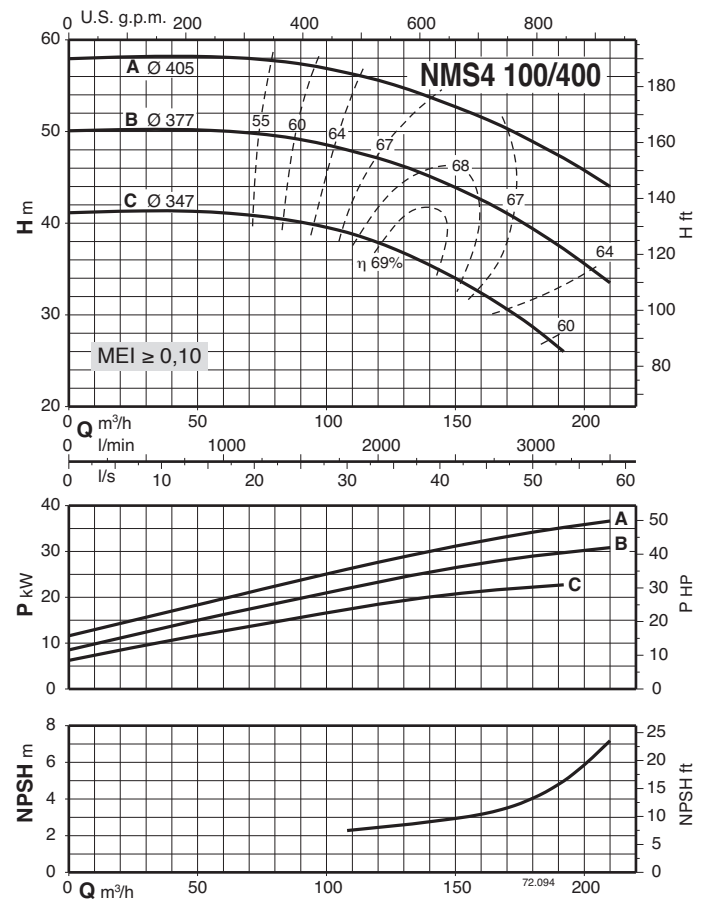
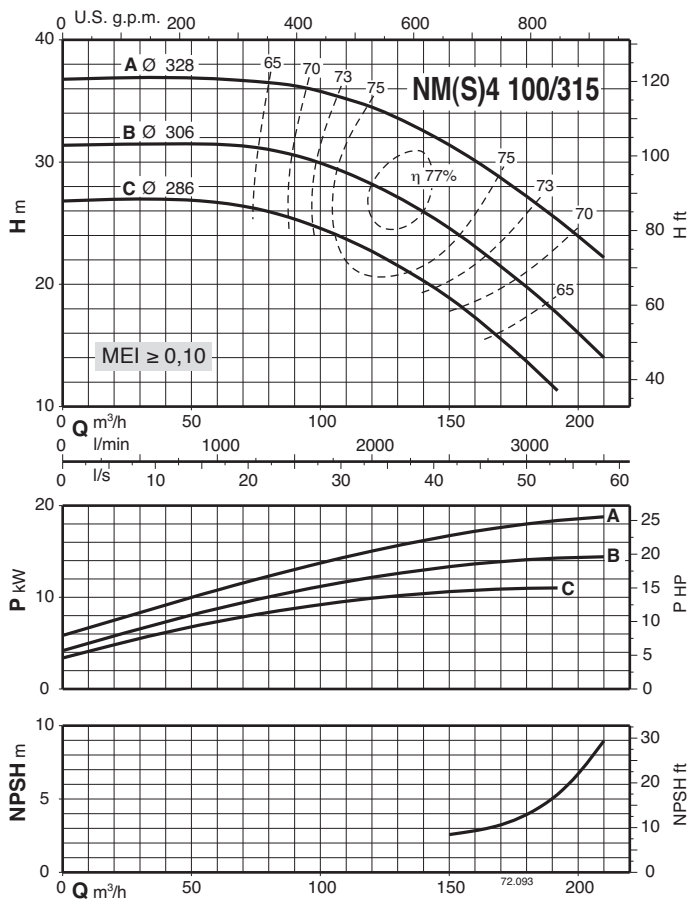
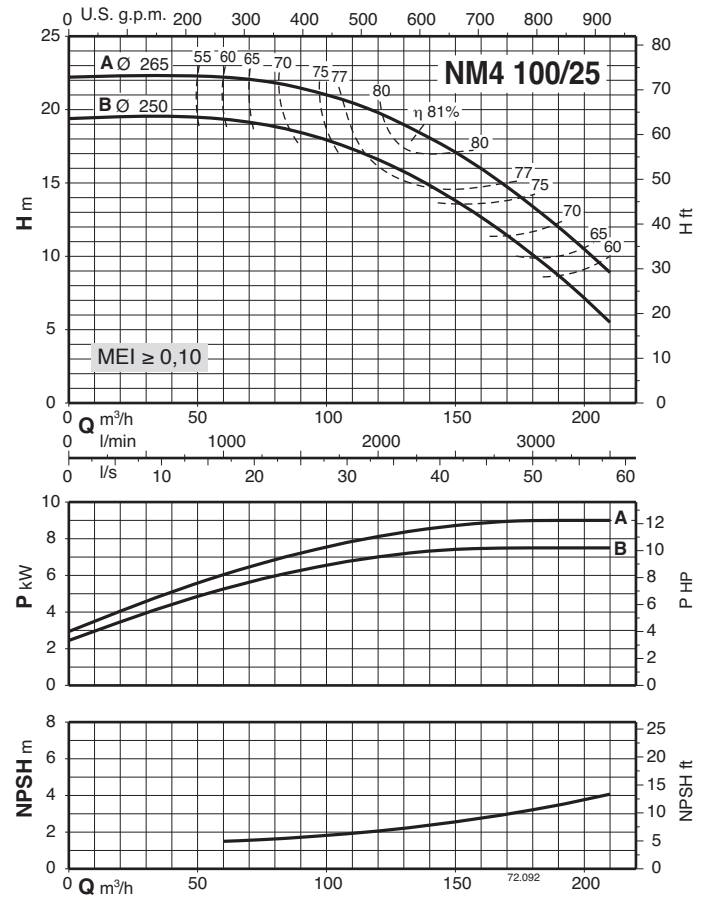
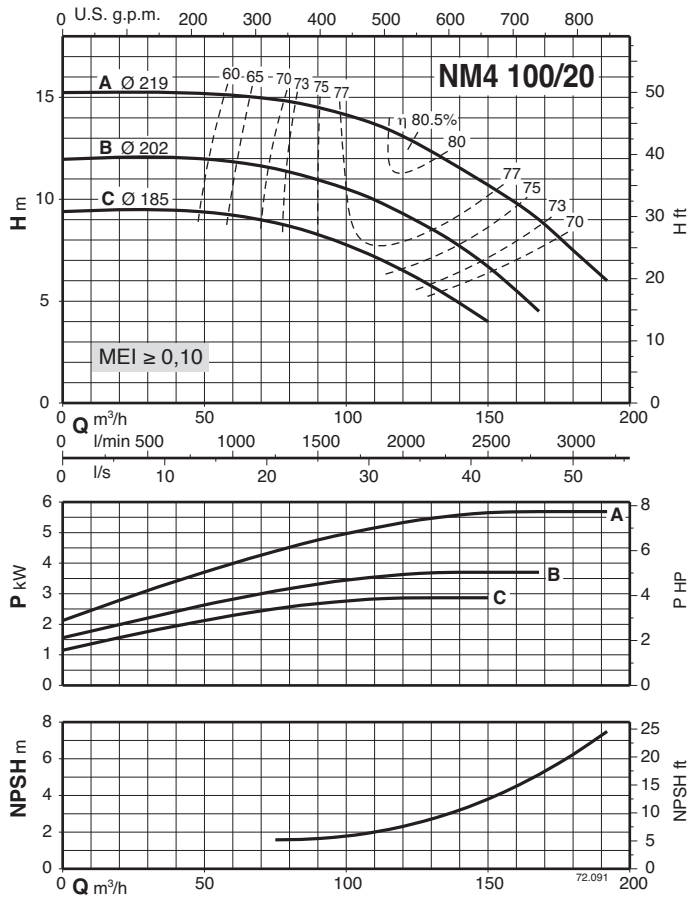

Characteristic curves $n \approx 1450$ rpm

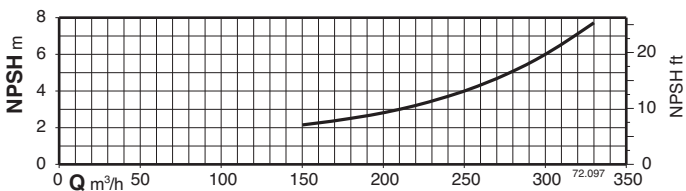
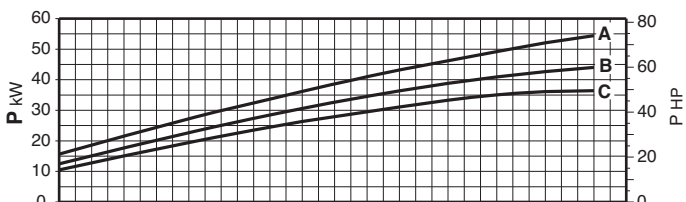
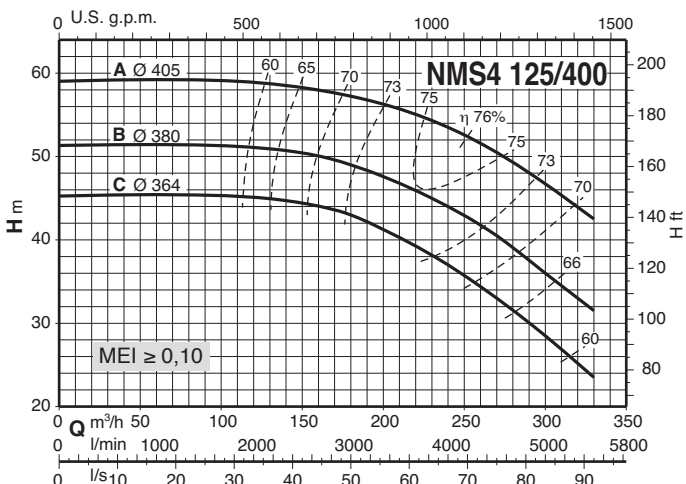
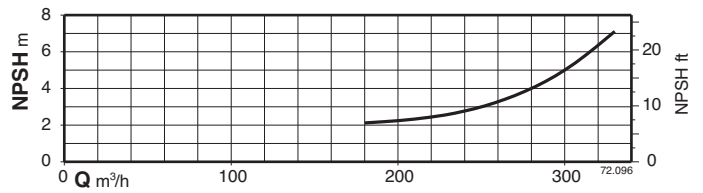
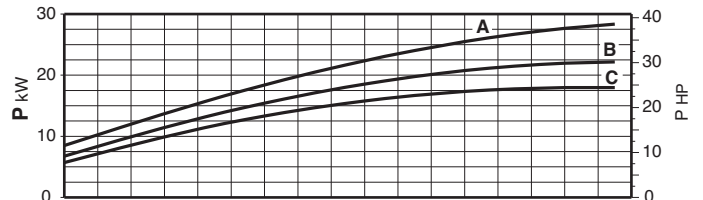
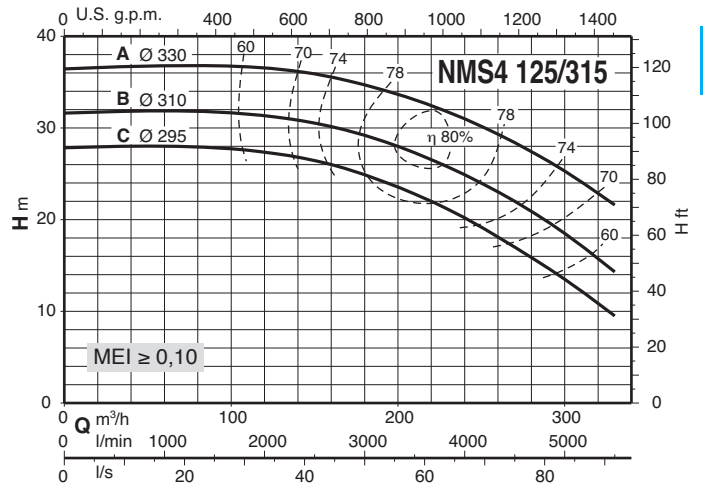
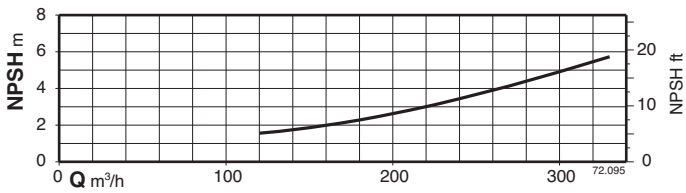
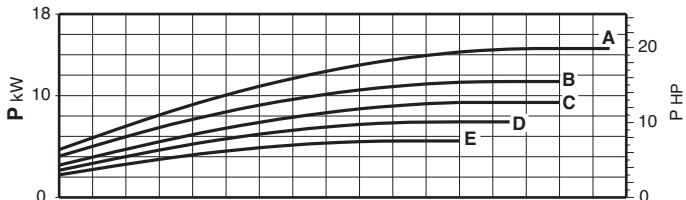
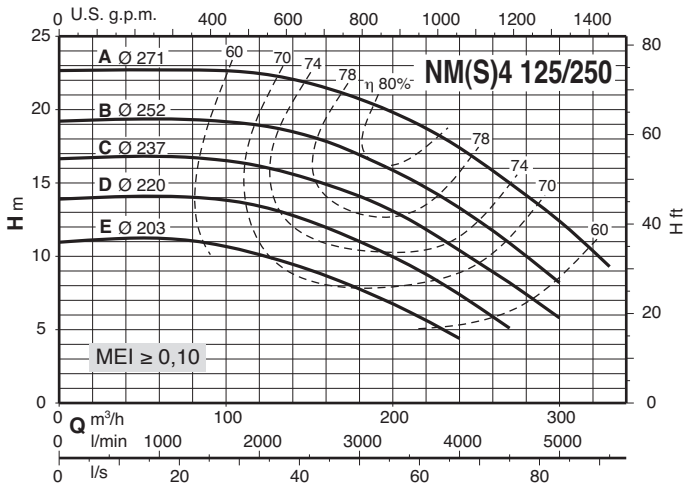

3

Characteristic curves $n \approx 1450$ rpm

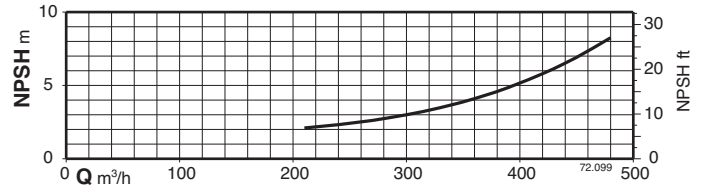
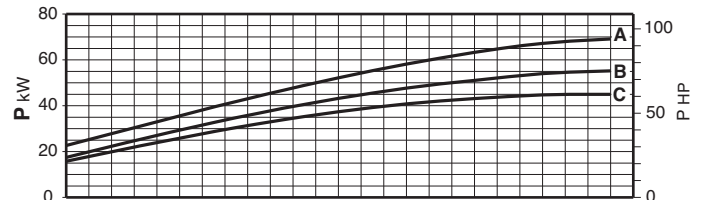
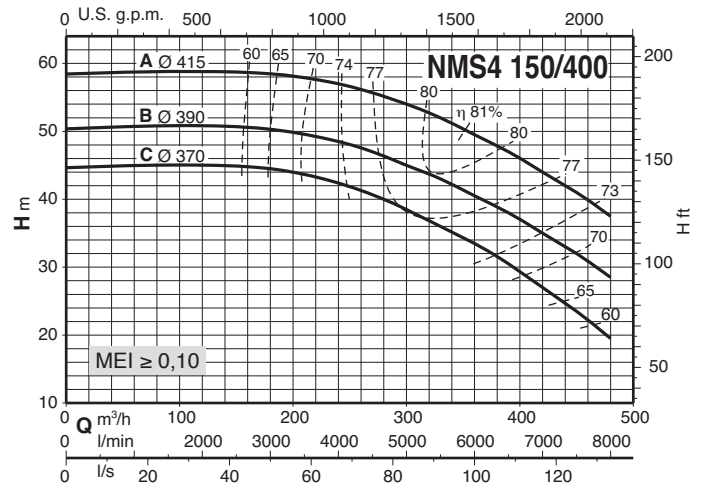
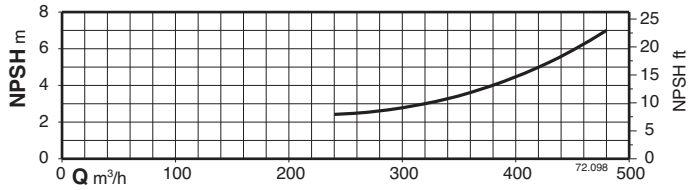
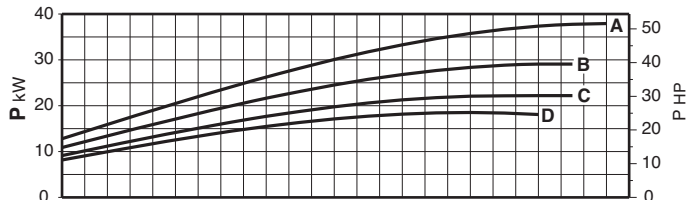
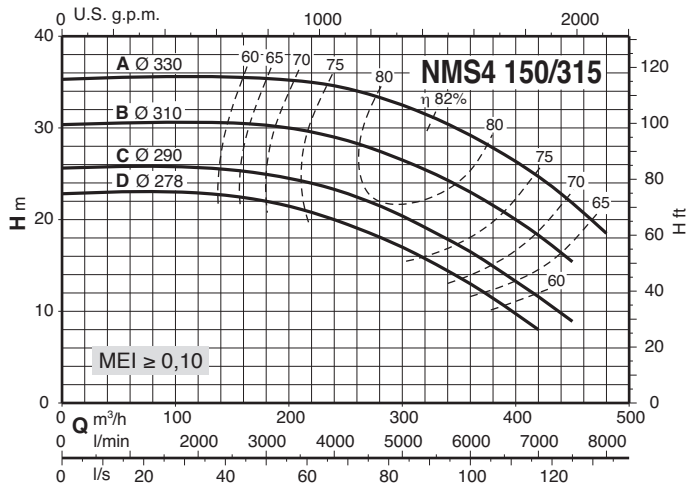

Dimensions and weights

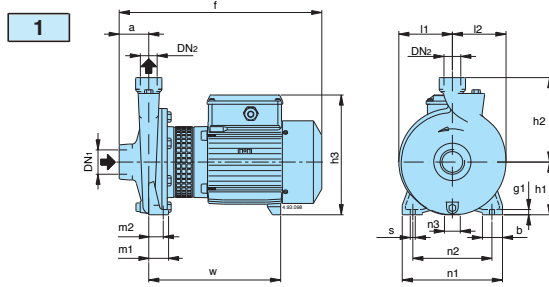

Standard construction

Picture	NM4	DN1	DN2	mm															kg	
				ISO 228																
		a	f	h1	h2	h3	m1	m2	n1	n2	n3	b	s	l1	l2	w	g			
1	NM4 25/12A/A	G 1 ^{1/2}	G 1	56	313	90	140	199	37,5	27,5	170	130	9	38	9,5	85	88	250	10	13,5
	NM4 25/160AE-BE	G 1 ^{1/2}	G 1	56	380	100	160	228	37,5	27,5	190	150	30	38	9,5	102	102	250	10	17,5
	NM4 25/200A/A-BE-CE	G 1 ^{1/2}	G 1	63	385	125	180	253	45	32,5	245	200	49	45	11,5	125	125	250	11	27-23-21,5

Bronze construction B-NM4

Picture	B-NM4	DN1	DN2	mm															kg	
				ISO 228																
		a	f	h1	h2	h3	m1	m2	n1	n2	n3	b	s	l1	l2	w	g			
1	B-NM4 25/160AE-BE	G 1 ^{1/2}	G 1	56	380	100	160	228	37,5	27,5	190	150	30	38	9,5	102	102	250	10	19-19
	B-NM4 25/200A/A-BE-CE	G 1 ^{1/2}	G 1	63	400	125	180	253	45	32,5	245	200	49	45	11,5	125	125	250	11	29-25-23

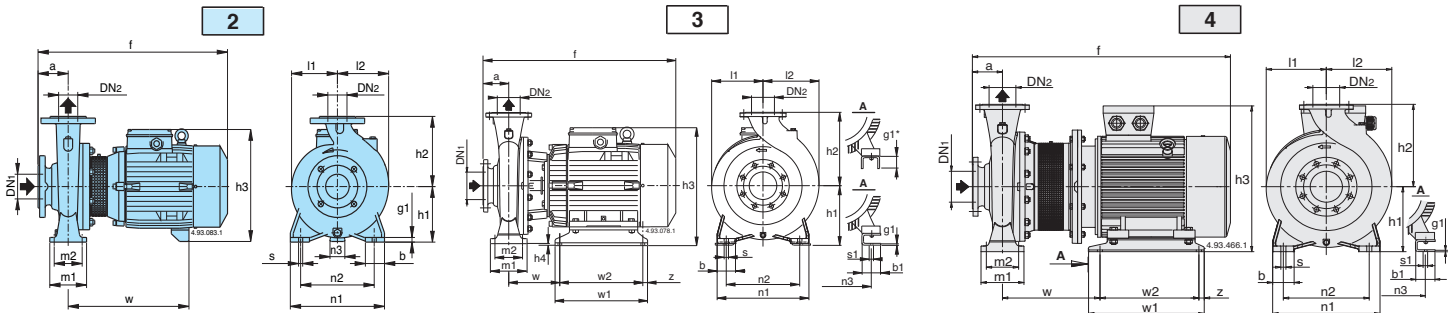

Picture	B-NM4	DN1	DN2	mm																		kg						
				a	f	h1	h2	h3	h4	m1	m2	n1	n2	n3	z	b	b1	s	s1	l1	l2		w	w1	w2	g1		
2	B-NM4 32/16A-B	50	32	80	410	132	160	260	-	100	70	240	190	47	-	50	-	14	-	120	120	255	-	-	12	38-38		
	B-NM4 32/20A/A-B	50	32	80	410	160	180	288	-	100	70	240	190	62	-	50	-	14	-	140	140	255	-	-	12	45-41		
	B-NM4 40/16A/A-B-C	65	40	80	410	132	160	260	-	100	70	240	190	47	-	50	-	14	-	119	119	255	-	-	12	43-40-38		
	B-NM4 40/20A/A-B/A	65	40	100	470	160	180	288	-	100	70	265	212	62	-	50	-	14	-	140	140	255	-	-	12	55-55		
3	B-NM4 4025/B/B-C/B	65	40	100	535	190	225	318	10	125	95	320	250	140	190	15	65	54	14	10	12	175	175	156	205	175	6	73-73
	B-NM4 4025/A/B	65	40	100	560	190	225	350	10	125	95	320	250	140	190	15	65	54	14	10	12	175	175	156	205	175	6	89
2	B-NM4 50/16A/A-B/A	65	50	100	470	160	180	288	-	100	70	265	212	62	-	50	-	14	-	127	141	255	-	-	12	55-55		
3	B-NM4 5025/C/B-D/A	65	50	100	535	190	225	318	10	125	95	320	250	140	190	15	65	54	14	10	12	175	175	156	205	175	6	79,5
	B-NM4 5025/A/B-B/B	65	50	100	560	190	225	350	10	125	95	320	250	140	190	15	65	54	14	10	12	175	175	156	205	175	6	105-92
2	B-NM4 65/16B/A-C/A	80	65	100	470	160	200	288	-	125	95	280	212	62	-	65	-	14	-	150	172	255	-	-	15	63-63		
	B-NM4 65/16A/A	80	65	100	495	160	200	306	-	125	95	280	212	60	-	65	-	14	-	150	172	300	-	-	15	71		

Flanges EN 1092-2

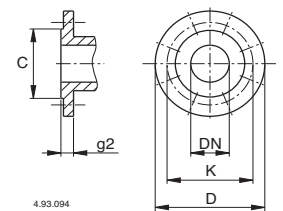

Picture	B-NMS4	DN1	DN2	mm																				kg	
				a	f	h1	h2	h3	h4	m1	m2	n1	n2	n3	z	b	b1	s	s1	l1	l2	w	w1		w2
4	B-NMS4 80/315A-B	100	80	125	948	250	315	457	-	160	120	400	315	254	20	80	60	18	15	220	232	271	435	395	6
	B-NMS4 80/400C	125	80	125	974	280	355	542	-	160	120	435	355	279	25	80	70	18	15	268	268	318	520	435	6
	B-NMS4 80/400B	125	80	125	1025	280	355	542	-	160	120	435	355	279	25	80	70	18	15	268	268	318	520	435	6
	B-NMS4 80/400A	125	80	125	1025	280	355	580	-	160	120	435	355	318	25	80	83	18	19	268	268	334	540	455	6
	B-NMS4 100/315B-C	125	100	140	963	250	315	457	-	160	120	400	315	254	20	80	60	18	15	230	250	271	435	395	6
	B-NMS4 100/315A	125	100	140	984	250	315	512	-	160	120	400	315	279	25	80	70	18	15	230	250	312	432	382	6
	B-NMS4 100/400C	125	100	140	1040	280	355	542	-	200	150	500	400	279	25	100	70	22	15	268	280	318	520	435	6
	B-NMS4 100/400B	125	100	140	1040	280	355	580	-	200	150	500	400	318	25	100	83	22	19	268	280	334	540	455	6
	B-NMS4 100/400A	125	100	140	1139	280	355	605	-	200	150	500	400	356	25	100	103	22	19	268	280	384	540	460	8
	B-NMS4 125/250A-B	150	125	140	951	250	315	457	-	160	120	400	315	254	20	80	60	18	15	235	268	259	435	395	6
	B-NMS4 125/315C	150	125	140	989	280	355	542	-	200	150	500	400	279	25	100	70	22	15	247	278	318	520	435	6
	B-NMS4 125/315B	150	125	140	1040	280	355	542	-	200	150	500	400	279	25	100	70	22	15	247	278	318	520	435	6
	B-NMS4 125/315A	150	125	140	1040	280	355	580	-	200	150	500	400	318	25	100	83	22	19	247	278	334	540	455	6
	B-NMS4 125/400C	150	125	140	1139	315	400	640	-	200	150	500	400	356	25	100	103	22	19	280	305	409	540	461	8
	B-NMS4 125/400B	150	125	140	1199	315	400	640	-	200	150	500	400	356	25	100	103	22	19	280	305	409	540	461	8
	B-NMS4 125/400A	150	125	140	1307	315	400	707	-	200	150	500	400	406	25	100	100	22	24	280	305	454	540	461	8
	B-NMS4 150/315D	200	150	160	1009	280	400	542	-	200	150	550	450	279	25	100	70	22	15	260	298	318	520	435	6
	B-NMS4 150/315C	200	150	160	1060	280	400	542	-	200	150	550	450	279	25	100	70	22	15	260	298	318	520	435	6
	B-NMS4 150/315B	200	150	160	1060	280	400	580	-	200	150	550	450	318	25	100	83	22	19	260	298	334	540	455	6
	B-NMS4 150/315A	200	150	160	1159	280	400	605	-	200	150	550	450	356	25	100	103	22	19	260	298	384	540	460	8
B-NMS4 150/400C	200	150	160	1219	315	450	640	-	200	150	550	450	356	25	100	103	22	19	295	328	409	540	461	8	
B-NMS4 150/400B	200	150	160	1277	315	450	707	-	200	150	550	450	406	25	100	100	22	24	295	328	404	540	461	8	
B-NMS4 150/400A	200	150	160	1280	315	450	747	-	200	150	550	450	457	25	100	100	22	24	295	328	432	625	535	6	

Pumps with packed gland, dimensions available on request (excluded NMS4).

Dimensions and weights

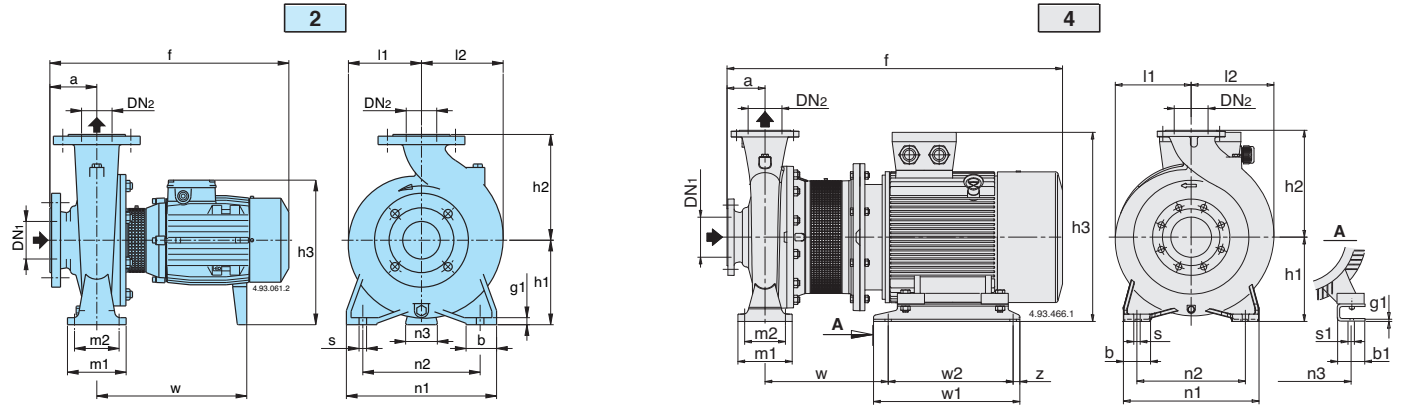

Standard construction

Flanges EN 1092-2

Picture	NM4	mm																				kg					
		DN1	DN2	a	f	h1	h2	h3	h4	m1	m2	n1	n2	n3	z	b	b1	s	s1	l1	l2		w	w1	w2	g1	
2	NM4 32/16AE-BE	50	32	80	410	132	160	260	-	100	70	240	190	47	-	50	-	14	-	120	120	255	-	-	12	30,5-30	
	NM4 32/20A/A-BE	50	32	80	410	160	180	288	-	100	70	240	190	62	-	50	-	14	-	140	140	255	-	-	12	38-34,5	
	NM4 40/16A/B-B/A-C/A	65	40	80	410	132	160	288	-	100	70	240	190	47	-	50	-	14	-	119	119	255	-	-	12	37-33-31	
	NM4 40/20A/A-B/A	65	40	100	470	160	180	288	-	100	70	265	212	62	-	50	-	14	-	140	140	255	-	-	12	41-40,5	
	NM4 40/25B/B-C/B	65	40	100	495	180	225	308	-	125	95	320	250	60	-	65	-	14	-	175	175	300	-	-	-	15	66,5-62
	NM4 40/25A/B				525			340														330					78
	NM4 50/16A/B-B/B	65	50	100	470	160	180	288	-	100	70	265	212	62	-	50	-	14	-	127	141	255	-	-	12	40-39,5	
	NM4 50/20C/B	65	50	100	480	160	200	288	-	100	70	265	212	62	-	50	-	14	-	140	153	265	-	-	-	14	44,5
	NM4 50/20A/B-B/B				505			60														310					57-52,5
	NM4 50/25C/B-D/A	65	50	100	490	180	225	308	-	125	95	320	250	60	-	65	-	14	-	175	175	300	-	-	-	15	68
	NM4 50/25A/B-B/B				530			340														330					85,5-78
	NM4 65/16B/A-C/A	80	65	100	470	160	200	288	-	125	95	280	212	62	-	65	-	14	-	150	172	255	-	-	-	15	48-48
	NM4 65/16A/A				495			60														300					54,5
	NM4 65/20B/A	80	65	100	505	180	225	308	-	125	95	320	250	60	-	65	-	14	-	155	175	310	-	-	-	15	61
	NM4 65/20A/A				525			340														330					73,5
	NM4 65/25B/A	80	65	100	540	200	250	360	-	160	120	360	280	60	-	80	-	18	-	175	190	345	-	-	-	18	97
	NM4 65/25A/A				645			385														415					116
	NM4 65/31B/A-C/A	80	65	125	670	225	280	410	-	160	120	400	315	75	-	80	-	18	-	220	220	415	-	-	-	20	164-153
	NM4 65/31A/A				720			385														465					176
	NM4 80/16C/A	100	80	125	495	180	225	288	-	125	95	320	250	62	-	65	-	14	-	165	193	255	-	-	-	15	53
NM4 80/16A/A-B/A	520				308			300														65,5-61					
NM4 80/20C/A	100	80	125	540	180	250	308	-	125	95	345	280	60	-	65	-	14	-	170	194	320	-	-	-	15	74,5	
NM4 80/20A/A-B/A				560			340														340					91-82	
NM4 80/25C/A	100	80	125	565	200	280	360	-	160	120	400	315	60	-	80	-	18	-	191	210	335	-	-	-	20	102	
NM4 80/25A/A-B/A				670			385														415					135-124	
NM4 80/31C/A	100	80	125	720	250	315	435	-	160	120	400	315	90	-	80	-	18	-	220	232	465	-	-	-	20	181	
3	NM4 80/315A/A-B/A	100	80	125	850	260	315	466	10	160	120	400	315	254	20	80	74	18	14	220	232	210	435	395	6	269-248	
	NM4 100/20B/A-C/A	125	100	125	565	200	280	360	-	160	120	360	280	60	-	80	-	18	-	180	212	330	-	-	-	20	99-90
NM4 100/20A/A	665				385			410														109					
2	NM4 100/25B/A	125	100	140	685	225	280	410	-	160	120	400	315	75	-	80	-	18	-	205	233	415	-	-	-	20	143
	NM4 100/25A/A				735			385														415					152
3	NM4 100/315B/A-C/A	125	100	140	865	260	315	466	10	160	120	400	315	254	20	80	74	18	14	230	250	210	435	395	6	280-261	
2	NM4 125/25D/A-E/A	150	125	140	685	250	355	435	-	160	120	400	315	90	-	80	-	18	-	235	268	415	-	-	-	20	161-149
	NM4 125/25C/A				735			465														173					
3	NM4 125/250A/A-B/A	150	125	140	865	260	355	466	10	160	120	400	315	254	20	80	74	18	14	235	268	210	435	395	6	261-243	

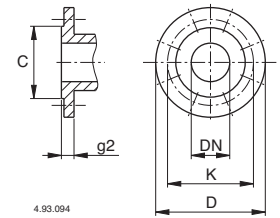

mm						
DN	C	K	D	Holes N°	g2	
				Ø		
32	76	100	140	4	19	18
40	84	110	150	4	19	18
50	99	125	165	4	19	20
65	118	145	185	4	19	20
80	132	160	200	8	19	22
100	156	180	220	8	19	24
125	184	210	250	8	19	24
150	211	240	285	8	23	26
200	266	295	340	8	23	30

Picture	NMS4	mm																				kg				
		DN1	DN2	a	f	h1	h2	h3	h4	m1	m2	n1	n2	n3	z	b	b1	s	s1	l1	l2		w	w1	w2	g1
4	NMS4 80/400C	125	80	125	974	280	355	542	-	160	120	435	355	279	25	80	70	18	15	268	268	318	520	435	6	-
	NMS4 80/400B	125	80	125	1025	280	355	542	-	160	120	435	355	279	25	80	70	18	15	268	268	318	520	435	6	-
	NMS4 80/400A	125	80	125	1025	280	355	580	-	160	120	435	355	318	25	80	83	18	19	268	268	334	540	455	6	413
	NMS4 100/315A	125	100	140	984	250	315	512	-	160	120	400	315	279	25	80	70	18	15	230	250	312	432	382	6	308
	NMS4 100/400C	125	100	140	1040	280	355	542	-	200	150	500	400	279	25	100	70	22	15	268	280	318	520	435	6	366
	NMS4 100/400B	125	100	140	1040	280	355	580	-	200	150	500	400	318	25	100	83	22	19	268	280	334	540	455	6	419
	NMS4 100/400A	125	100	140	1139	280	355	605	-	200	150	500	400	356	55	100	103	22	19	268	280	384	540	460	8	506
	NMS4 125/315C	150	125	140	989	280	355	542	-	200	150	500	400	279	25	100	70	22	15	247	278	318	520	435	6	331
	NMS4 125/315B	150	125	140	1040	280	355	542	-	200	150	500	400	279	25	100	70	22	15	247	278	318	520	435	6	356
	NMS4 125/315A	150	125	140	1040	280	355	580	-	200	150	500	400	318	25	100	83	22	19	247	278	334	540	455	6	-
	NMS4 125/400C	150	125	140	1139	315	400	640	-	200	150	500	400	356	25	100	103	22	19	280	305	409	540	461	8	-
	NMS4 125/400B	150	125	140	1199	315	400	640	-	200	150	500	400	356	25	100	103	22	19	280	305	409	540	461	8	524
	NMS4 125/400A	150	125	140	1307	315	400	707	-	200	150	500	400	406	25	100	100	22	24	280	305	454	540	461	8	-
	NMS4 150/315D	200	150	160	1009	280	400	542	-	200	150	550	450	279	25	100	70	22	15	260	298	318	520	435	6	349
	NMS4 150/315C	200	150	160	1060	280	400	542	-	200	150	550	450	279	25	100	70	22	15	260	298	318	520	435	6	374
	NMS4 150/315B	200	150	160	1060	280	400	580	-	200	150	550	450	318	25	100	83	22	19	260	298	334	540	455	6	421
	NMS4 150/315A	200	150	160	1159	280	400	605	-	200	150	550	450	356	55	100	103	22	19	260	298	384	540	460	8	-
	NMS4 150/400C	200	150	160	1219	315	450	640	-	200	150	550	450	356	25	100	103	22	19	295	328	409	540	461	8	594
	NMS4 150/400B	200	150	160	1277	315	450	707	-	200	150	550	450	406	25	100	100	22	24	295	328	404	540	461	8	715
	NMS4 150/400A	200	150	160	1280	315	450	747	-	200	150	550	450	457	45	100	100	22	24	295	328	432	625	535	6	-

Pumps with packed gland, dimensions available on request (excluded NMS4).

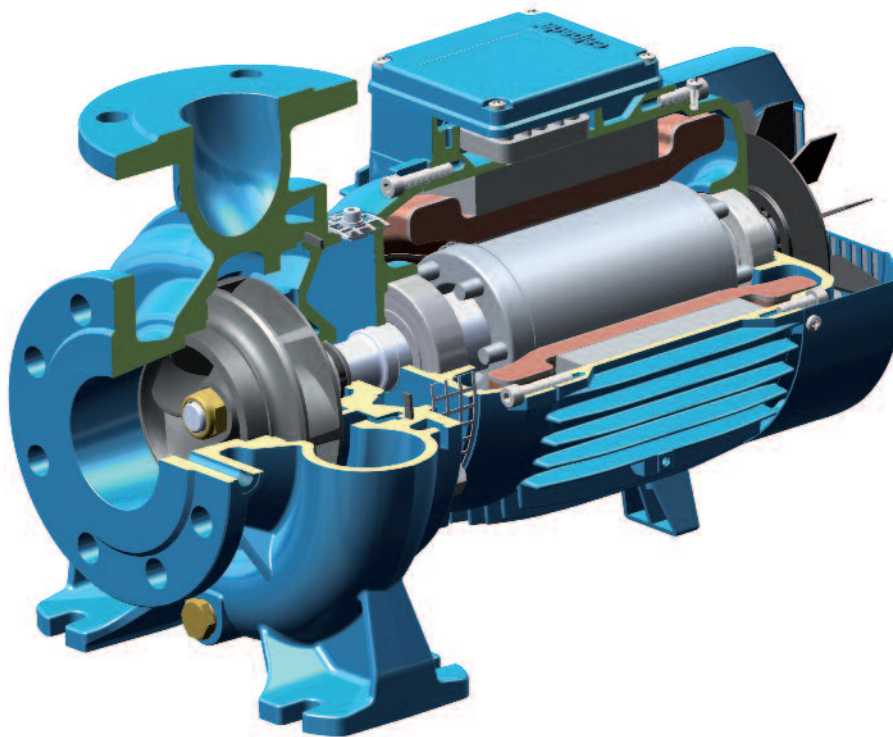

Cutting edge hydraulics

The geometry of the impeller and the pump casing are optimized to achieve maximum efficiency and the best suction capability.

Flexible

The option to choose between cast iron and bronze materials for the hydraulic parts in contact with the pumped liquid allows NM and NM4 series pumps to be selected for use with different types of liquids.

Compact Design

The compact design allows for easy installation even in confined spaces.

Exclusive design

An innovative, patented guard prevents contact with rotating parts, proving protection to the end user whilst allowing for inspection of the mechanical seal.

Reliable

The bearing and shaft are designed to ensure the reduction of the stress, providing high reliability under all operating conditions.

Features

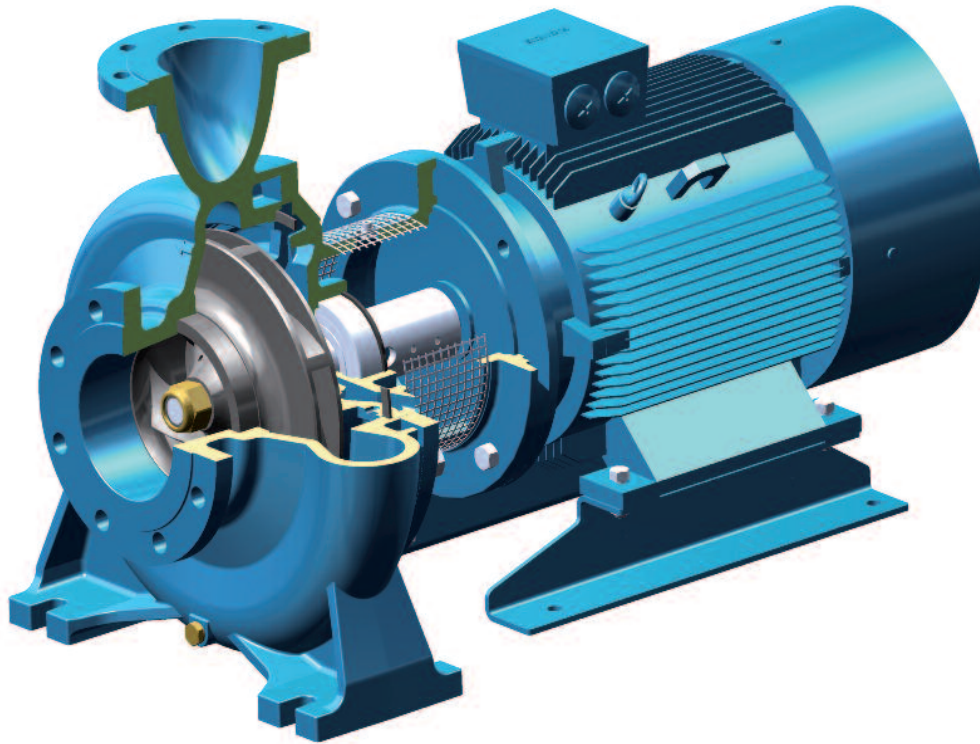

Cutting edge hydraulics

The geometry of the impeller and the pump casing are optimized to achieve maximum efficiency and the best suction capability.

Flexibility

The option to choose between cast iron and bronze materials for the hydraulic parts in contact with the pumped liquid allows NMS and NMS4 series pumps to be selected for use with different types of liquids.

New lantern bracket construction

The lantern brackets incorporate a thrust bearing on the hydraulic side which guarantees the elimination of additional loads on the motor bearings. The flange is sized to be used with standard motors B35.

Exclusive design

An innovative, patented guard prevents contact with rotating parts, proving protection to the end user whilst allowing for inspection of the mechanical seal.

Simplified motor maintenance

The presence of the thrust bearing on the hydraulic side makes it easier to remove the motor, facilitating maintenance operations and eliminating the risks of damage to the hydraulic parts.